

RAHMENFORM | FORMA ANELLO



SERIE B502-R178

BEWEGLICH - ORIENTABILE



**68 MM AUSSCHNITT
FORO 68 MM**

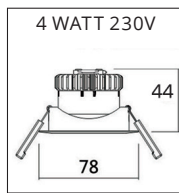
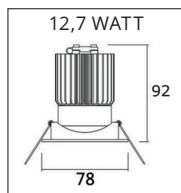
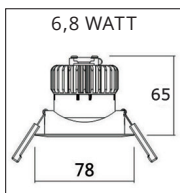

Ringform Forma anello	Art. Nr.	Weiß Bianco	Schwarz Nero	
	B502-R178	03		68 mm
	B502-R178		05	68 mm

PASSENDE LED EINSÄTZE | MODULI LED ABBINATI



Für mehr Informationen
siehe nächste Seite
Per maggiori informazioni
consulta la prossima pagina



ZUSAMMENBAU MONTAGGIO

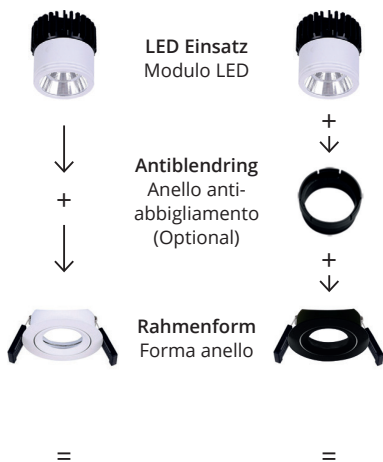

Innenansicht
Vista interna

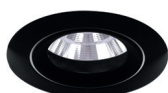

Innenansicht
Vista interna

OPTIONAL | OPZIONALE



B566-RR6004
Reflektor gold 60°
Riflettore oro 60°



B5R-RAB4805
Antiblending
Anello antiabbigliamento



B566-RR15
Reflektor 15°
Riflettore 15°



B500-GU10 05
Halter für GU10
Supporto per GU10



B566-RR25
Reflektor 25°
Riflettore 25°

LED EINSÄTZE | MODULI LED

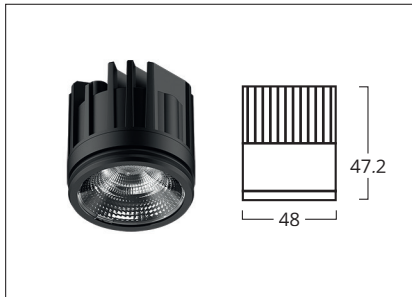

SERIE B500
6,3 W | 700 mA | 9 V | 840 lm
COB - CREE | CRI > 90



OHNE NETZTEIL SENZA ALIMENTATORE

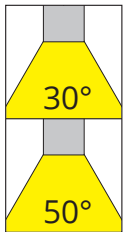

Art. Nr. BRILUX	W	Volt	Kelvin
B563-27 30 70	6,3 W	700 mA / 9V	2700 K
B563-30 30 70	6,3 W	700 mA / 9V	3000 K
B563-40 30 70	6,3 W	700 mA / 9V	4000 K
B563-27 50 70	6,3 W	700 mA / 9V	2700 K
B563-30 50 70	6,3 W	700 mA / 9V	3000 K
B563-40 50 70	6,3 W	700 mA / 9V	4000 K



MIT TRIAC DIM NETZTEIL CON ALIMENTATORE TRIAC DIM

Art. Nr. BRILUX	W	Volt	Kelvin
B96-PE294B1270	10,5 W	200 - 240 VAc	/

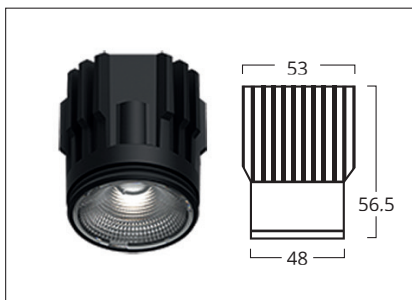

SERIE B500
10,8 W | 350 mA | 37 V | 1440 lm
COB - CREE | CRI > 90



OHNE NETZTEIL SENZA ALIMENTATORE

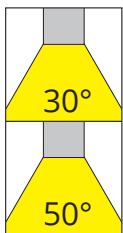

Art. Nr. BRILUX	W	Volt	Kelvin
B5108-27 30 35	10,8 W	350 mA / 37V	2700 K
B5108-30 30 35	10,8 W	350 mA / 37V	3000 K
B5108-40 30 35	10,8 W	350 mA / 37V	4000 K
B5108-27 50 35	10,8 W	350 mA / 37V	2700 K
B5108-30 50 35	10,8 W	350 mA / 37V	3000 K
B5108-40 50 35	10,8 W	350 mA / 37V	4000 K



MIT TRIAC DIM NETZTEIL CON ALIMENTATORE TRIAC DIM

Art. Nr. BRILUX	W	Volt	Kelvin
B96-PE294B4233	12,80 W	200 - 240 VAc	/

LED EINSÄTZE | MODULI LED



SERIE B500

6,8 W | 700 mA | 9 V | 660 lm

COB - CREE | CRI > 90



**MIT TRIAC DIM NETZTEIL
CON ALIMENTATORE TRIAC DIM**

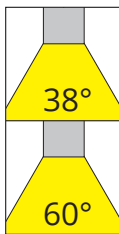

Art. Nr. BRILUX	W	Volt	Kelvin
B566-27 38 70 ED	6,8 W	200-250 V T-Dim	2700 K
B566-30 38 70 ED	6,8 W	200-250 V T-Dim	3000 K
B566-40 38 70 ED	6,8 W	200-250 V T-Dim	4000 K
B566-27 60 70 ED	6,8 W	200-250 V T-Dim	2700 K
B566-30 60 70 ED	6,8 W	200-250 V T-Dim	3000 K
B566-40 60 70 ED	6,8 W	200-250 V T-Dim	4000 K

Dim TO WARM	Art. Nr. BRILUX	W	Volt	Kelvin
	B566-2770 60 70E*	6 W	350 mA / 18V	1800-3000 K

*mit / con 1 - 10 V Driver

**OHNE NETZTEIL
SENZA ALIMENTATORE**

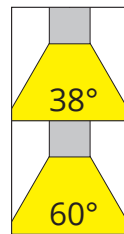

Art. Nr. BRILUX	W	Volt	Kelvin
B566-27 38 70	6,8 W	700 mA / 9V	2700 K
B566-30 38 70	6,8 W	700 mA / 9V	3000 K
B566-40 38 70	6,8 W	700 mA / 9V	4000 K
B566-27 60 70	6,8 W	700 mA / 9V	2700 K
B566-30 60 70	6,8 W	700 mA / 9V	3000 K
B566-40 60 70	6,8 W	700 mA / 9V	4000 K

Dim TO WARM	Art. Nr. BRILUX	W	Volt	Kelvin
	B566-2770 60 70	6 W	350 mA / 18V	1800-3000 K
FÜR NETZ-SPANNUNG 230V FLAT	B560-276000	4 W	230 V / AC	2700 K
	B560-306000	4 W	230 V / AC	3000 K
RGBW	B5100-RGBW35	4 x 1 W	4x350 mA / 3V	W-3000 K



SERIE B500

12,7 W | 350 mA | 37 V | 1320 lm

COB - CREE | CRI > 90



**MIT TRIAC DIM NETZTEIL
CON ALIMENTATORE TRIAC DIM**

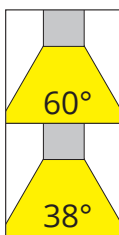

Art. Nr. BRILUX	W	Volt	Kelvin
B5132-27 60 35ED	12,7 W	200-250 V T-Dim	2700 K
B5132-30 60 35ED	12,7 W	200-250 V T-Dim	3000 K
B5132-40 60 35ED	12,7 W	200-250 V T-Dim	4000 K
B5132-27 38 35ED	12,7 W	200-250 V T-Dim	2700 K
B5132-30 38 35ED	12,7 W	200-250 V T-Dim	3000 K
B5132-40 38 35ED	12,7 W	200-250 V T-Dim	4000 K

Dim TO WARM	Art. Nr. BRILUX	W	Volt	Kelvin
	B5132-2770 60 35E*	12 W	350 mA / 37V	1800-3000 K

*mit / con 1 - 10 V Driver

**OHNE NETZTEIL
SENZA ALIMENTATORE**

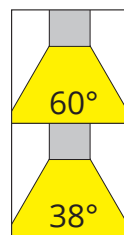

Art. Nr. BRILUX	W	Volt	Kelvin
B5132-27 60 35	12,7 W	350 mA / 37V	2700 K
B5132-30 60 35	12,7 W	350 mA / 37V	3000 K
B5132-40 60 35	12,7 W	350 mA / 37V	4000 K
B5132-27 38 35	12,7 W	350 mA / 37V	2700 K
B5132-30 38 35	12,7 W	350 mA / 37V	3000 K
B5132-40 38 35	12,7 W	350 mA / 37V	4000 K

Dim TO WARM	Art. Nr. BRILUX	W	Volt	Kelvin
	B5132-2770 60 35	12 W	350 mA / 37V	1800-3000 K