

## RAHMENFORM | FORMA ANELLO



**SERIE B501-Q185**

**BEWEGLICH - ORIENTABILE**



**75x75 MM AUSSCHNITT**  
DIAMETRO 75x75 MM

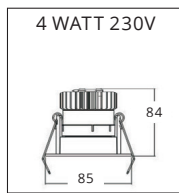
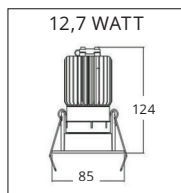
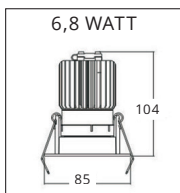

Ringform Forma anello	Art. Nr.	Weiß Bianco	Schwarz Nero	
	B501-Q185	03		75x75 mm
	B501-Q185		05	75x75 mm

## PASSENDE LED EINSÄTZE | MODULI LED ABBINATI



Für mehr Informationen  
siehe nächste Seite  
Per maggiori informazioni  
consulta la prossima pagina



## ZUSAMMENBAU MONTAGGIO

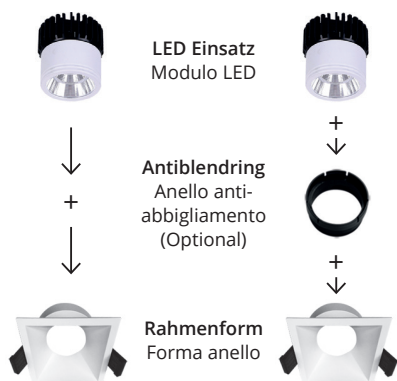

## OPTIONAL | OPZIONALE

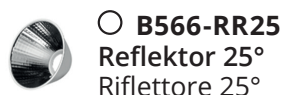
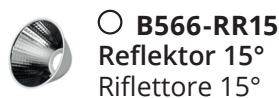
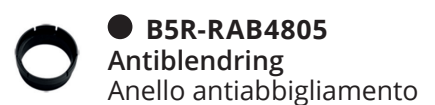

Innenansicht  
Vista interna



Innenansicht  
Vista interna

# LED EINSÄTZE | MODULI LED

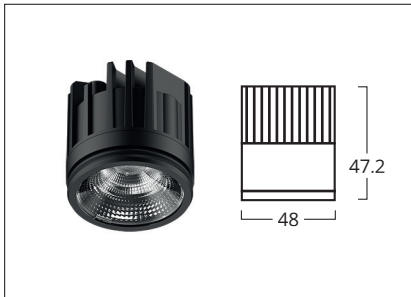

**SERIE B500**  
**6,3 W | 700 mA | 9 V | 840 lm**  
**COB - CREE | CRI > 90**



## OHNE NETZTEIL SENZA ALIMENTATORE

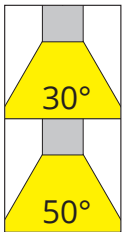

Art. Nr. BRILUX	W	Volt	Kelvin
B563-27 30 70	6,3 W	700 mA / 9V	2700 K
B563-30 30 70	6,3 W	700 mA / 9V	3000 K
B563-40 30 70	6,3 W	700 mA / 9V	4000 K
B563-27 50 70	6,3 W	700 mA / 9V	2700 K
B563-30 50 70	6,3 W	700 mA / 9V	3000 K
B563-40 50 70	6,3 W	700 mA / 9V	4000 K



## MIT TRIAC DIM NETZTEIL CON ALIMENTATORE TRIAC DIM

Art. Nr. BRILUX	W	Volt	Kelvin
B96-PE294B1270	10,5 W	200 - 240 VAc	/

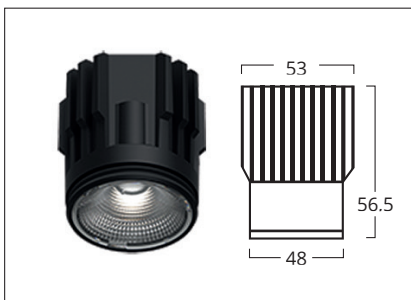

**SERIE B500**  
**10,8 W | 350 mA | 37 V | 1440 lm**  
**COB - CREE | CRI > 90**



## OHNE NETZTEIL SENZA ALIMENTATORE

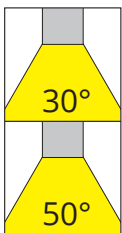

Art. Nr. BRILUX	W	Volt	Kelvin
B5108-27 30 35	10,8 W	350 mA / 37V	2700 K
B5108-30 30 35	10,8 W	350 mA / 37V	3000 K
B5108-40 30 35	10,8 W	350 mA / 37V	4000 K
B5108-27 50 35	10,8 W	350 mA / 37V	2700 K
B5108-30 50 35	10,8 W	350 mA / 37V	3000 K
B5108-40 50 35	10,8 W	350 mA / 37V	4000 K



## MIT TRIAC DIM NETZTEIL CON ALIMENTATORE TRIAC DIM

Art. Nr. BRILUX	W	Volt	Kelvin
B96-PE294B4233	12,80 W	200 - 240 VAc	/

# LED EINSÄTZE | MODULI LED



**SERIE B500**  
**6,8 W | 700 mA | 9 V | 660 lm**  
**COB - CREE | CRI > 90**



## MIT TRIAC DIM NETZTEIL CON ALIMENTATORE TRIAC DIM

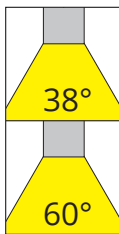

Art. Nr. BRILUX	W	Volt	Kelvin
B566-27 38 70 ED	6,8 W	200-250 V T-Dim	2700 K
B566-30 38 70 ED	6,8 W	200-250 V T-Dim	3000 K
B566-40 38 70 ED	6,8 W	200-250 V T-Dim	4000 K
B566-27 60 70 ED	6,8 W	200-250 V T-Dim	2700 K
B566-30 60 70 ED	6,8 W	200-250 V T-Dim	3000 K
B566-40 60 70 ED	6,8 W	200-250 V T-Dim	4000 K

Dim TO WARM	Art. Nr. BRILUX	W	Volt	Kelvin
	B566-2770 60 70E*	6 W	350 mA / 18V	1800-3000 K

\*mit / con 1 - 10 V Driver

## OHNE NETZTEIL SENZA ALIMENTATORE

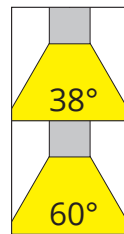

Art. Nr. BRILUX	W	Volt	Kelvin
B566-27 38 70	6,8 W	700 mA / 9V	2700 K
B566-30 38 70	6,8 W	700 mA / 9V	3000 K
B566-40 38 70	6,8 W	700 mA / 9V	4000 K
B566-27 60 70	6,8 W	700 mA / 9V	2700 K
B566-30 60 70	6,8 W	700 mA / 9V	3000 K
B566-40 60 70	6,8 W	700 mA / 9V	4000 K

Dim TO WARM	Art. Nr. BRILUX	W	Volt	Kelvin
	B566-2770 60 70	6 W	350 mA / 18V	1800-3000 K
FÜR NETZ-SPANNUNG 230V FLAT	B560-276000	4 W	230 V / AC	2700 K
	B560-306000	4 W	230 V / AC	3000 K
RGBW	B5100-RGBW35	4 x 1 W	4x350 mA / 3V	W-3000 K



**SERIE B500**  
**12,7 W | 350 mA | 37 V | 1320 lm**  
**COB - CREE | CRI > 90**



## MIT TRIAC DIM NETZTEIL CON ALIMENTATORE TRIAC DIM

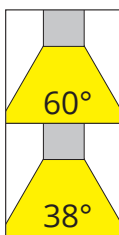

Art. Nr. BRILUX	W	Volt	Kelvin
B5132-27 60 35ED	12,7 W	200-250 V T-Dim	2700 K
B5132-30 60 35ED	12,7 W	200-250 V T-Dim	3000 K
B5132-40 60 35ED	12,7 W	200-250 V T-Dim	4000 K
B5132-27 38 35ED	12,7 W	200-250 V T-Dim	2700 K
B5132-30 38 35ED	12,7 W	200-250 V T-Dim	3000 K
B5132-40 38 35ED	12,7 W	200-250 V T-Dim	4000 K

Dim TO WARM	Art. Nr. BRILUX	W	Volt	Kelvin
	B5132-2770 60 35E*	12 W	350 mA / 37V	1800-3000 K

\*mit / con 1 - 10 V Driver

## OHNE NETZTEIL SENZA ALIMENTATORE

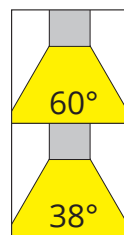

Art. Nr. BRILUX	W	Volt	Kelvin
B5132-27 60 35	12,7 W	350 mA / 37V	2700 K
B5132-30 60 35	12,7 W	350 mA / 37V	3000 K
B5132-40 60 35	12,7 W	350 mA / 37V	4000 K
B5132-27 38 35	12,7 W	350 mA / 37V	2700 K
B5132-30 38 35	12,7 W	350 mA / 37V	3000 K
B5132-40 38 35	12,7 W	350 mA / 37V	4000 K

Dim TO WARM	Art. Nr. BRILUX	W	Volt	Kelvin
	B5132-2770 60 35	12 W	350 mA / 37V	1800-3000 K